

EYE/FACEWASH



PARTS

SERVICE



KNOWLEDGE



SELF-CONTAINED

QUALITY



INNOVATION

**Encon**<sup>®</sup>  
SAFETY PRODUCTS

**SHOWER, EYEWASH & FACEWASH PRODUCTS**

LEADERS

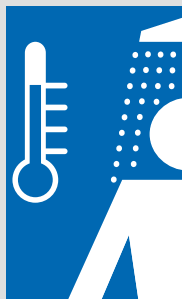

SOLUTIONS



EXCELLENCE

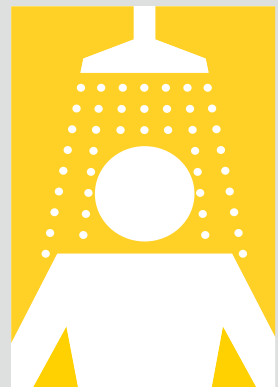

SAFETY



2017

# Catalog Contents

## Combination Eyewash/Facewash Showers

<i>Galvanized Piping</i>	5
<i>Stainless Steel Piping</i>	10
<i>PVC Piping</i>	12
<i>Corrosion-Resistant Coating</i>	13
<i>Vertical &amp; Horizontal Showers</i>	14

## Freeze – Resistant Showers

<i>Freeze &amp; Scald Protection Valves</i>	16
<i>Subsurface Showers &amp; Eye/Facewash</i>	17
<i>Through-Wall Shower &amp; Eyewash</i>	18

## Self-Contained

<i>Aquarion®</i>	20
<i>Helios®</i>	21
<i>Gravity Fed</i>	22
<i>Standard Pressurized Portable Eyewash</i>	23
<i>Large Pressurized Portable Eyewash</i>	24
<i>Personal Flushing Stations</i>	25

## Eyewash & Facewash

<i>Wall Mount</i>	27
<i>Supply Mount</i>	29
<i>Pedestal Mount</i>	31

## Freeze-Protected Showers

<i>Therma-Flow® Freeze-Protected Showers</i>	34
<i>Therma-Flow® PLUS Freeze-Protected Shower Enclosures</i>	36

## Tempered Water Systems

<i>Electrically Heated &amp; Blended</i>	39
<i>Air Driven</i>	40
<i>Steam Heated &amp; Blended</i>	41
<i>Saf-T-Flo® Fail-Safe Blending</i>	42

## Accessories & Parts

<i>Alarm Systems &amp; Lighting</i>	43
<i>Awareness 100™ Signage</i>	45
<i>Awareness® &amp; Awareness 360™ Signage</i>	46
<i>Emergency Signs</i>	47
<i>Shower Accessories &amp; Test Units</i>	48
<i>Assemblies - Heads &amp; Nozzles</i>	50
<i>Bowls &amp; Covers</i>	51
<i>Self-Contained</i>	51
<i>Activation Kits &amp; Valves</i>	52
<i>Protection Valves &amp; Fittings</i>	53
<i>Alarms</i>	53
<i>Curtains &amp; Testing Accessories</i>	53

## Representative Performance Data

**54**

## Limited Warranty Statement

**54**

## Numerical Parts Index

**55**

## Key

<b>ABS</b>	<i>Acrylonitrile Butadiene Styrenes</i>
<b>BCP</b>	<i>Brass Chrome-Plated</i>
<b>CP</b>	<i>Chrome-Plated</i>
<b>DH</b>	<i>Drench Hose</i>
<b>FTR</b>	<i>Foot Treadle</i>
<b>PVC</b>	<i>Poly Vinyl Chloride</i>
<b>SS</b>	<i>Stainless Steel</i>



**E**ncon Safety Products built its reputation as “**The most sought-after name in Industrial Safety**” with years of **Experience**, through product **Innovation**, and with an unwavering **Commitment to Excellence**. Today, with over 50 years of commitment to excellence in product design and development, Encon® continues to lead the way with the most reliable and innovative emergency shower and eyewash products.

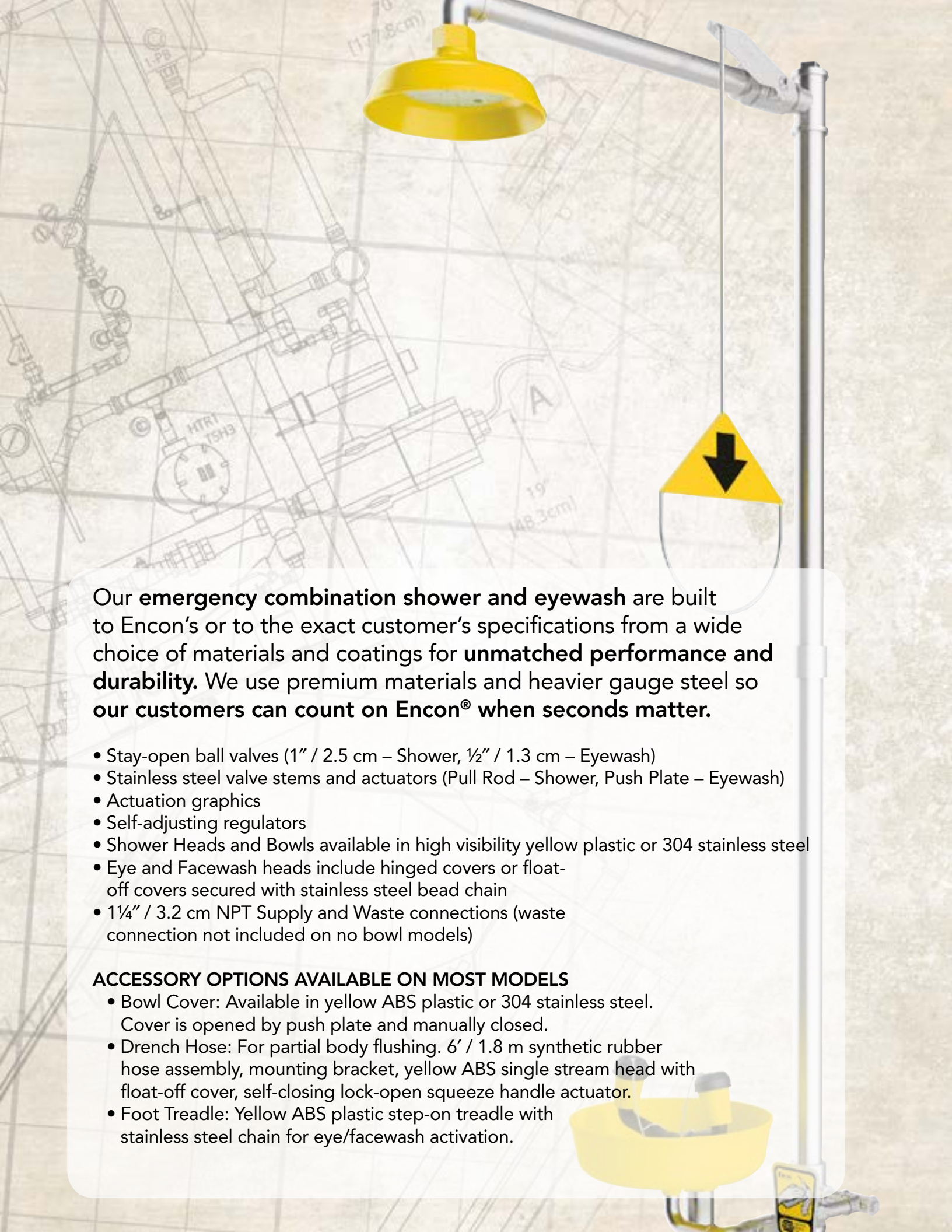

Our **emergency combination shower and eyewash** are built to Encon's or to the exact customer's specifications from a wide choice of materials and coatings for **unmatched performance and durability**. We use premium materials and heavier gauge steel so **our customers can count on Encon® when seconds matter**.

- Stay-open ball valves (1" / 2.5 cm – Shower, ½" / 1.3 cm – Eyewash)
- Stainless steel valve stems and actuators (Pull Rod – Shower, Push Plate – Eyewash)
- Actuation graphics
- Self-adjusting regulators
- Shower Heads and Bowls available in high visibility yellow plastic or 304 stainless steel
- Eye and Facewash heads include hinged covers or float-off covers secured with stainless steel bead chain
- 1¼" / 3.2 cm NPT Supply and Waste connections (waste connection not included on no bowl models)

#### **ACCESSORY OPTIONS AVAILABLE ON MOST MODELS**

- Bowl Cover: Available in yellow ABS plastic or 304 stainless steel. Cover is opened by push plate and manually closed.
- Drench Hose: For partial body flushing. 6' / 1.8 m synthetic rubber hose assembly, mounting bracket, yellow ABS single stream head with float-off cover, self-closing lock-open squeeze handle actuator.
- Foot Treadle: Yellow ABS plastic step-on treadle with stainless steel chain for eye/facewash activation.

# Combination Showers Eyewash/Facewash

## Galvanized Piping

### PIPING AND VALVE CHOICES

- Schedule 80 hot dip galvanized steel piping
- Chrome-plated bronze ball valves & ball

### SHIP WEIGHT

Shower — 59 lb / 26.76 kg  
 Shower with FTR — 61 lb / 27.66 kg  
 Shower with DH — 62 lb / 21.12 kg



**Model 01050260**  
 20 gpm / 75.7 lpm Shower,  
 Facewash with ABS Heads &  
 Wye, Yello-Bowl®

**Model 01050216**  
 30 gpm / 113.6 lpm Shower,  
 Facewash with ABS Heads &  
 Wye, Yello-Bowl®



**Note:** ABS Facewash assembly, 8 gpm / 30.3 lpm Head available with BCP Wye. See model on page 7.

**Model 01050251**  
 20 gpm / 75.7 lpm Shower,  
 Eyewash with ABS Heads &  
 Wye, Yello-Bowl®

**Model 01050207**  
 30 gpm / 113.6 lpm Shower,  
 Eyewash with ABS Heads &  
 Wye, Yello-Bowl®



**Note:** ABS Eyewash assembly, 3.2 gpm / 12.1 lpm



**Model 01050217P20**  
 20 gpm / 75.7 lpm Shower,  
 Eyewash with Acetal Heads &  
 BCP Wye, Yello-Bowl®

**Model 01050217**  
 30 gpm / 113.6 lpm Shower,  
 Eyewash with Acetal Heads &  
 BCP Wye, Yello-Bowl®



**Note:** Acetal eyewash & BCP Wye, 2.4 gpm / 9.1 lpm. Bowl covers available on models with BCP Wye. See bowl covered model on page 6.



**Note:** Every model in this section includes a 7" x 11" / 17.7 cm x 27.9 cm sign, part number 01112892. See signs on page 47.

# Combination Showers Eyewash/Facewash

## Galvanized Piping

### Model 01050209P20

20 gpm / 75.7 lpm Shower,  
Eyewash with ABS Heads &  
Wye, Strainer, Yello-Bowl®

### Model 01050209

30 gpm / 113.6 lpm Shower,  
Eyewash with ABS Heads &  
Wye, Strainer, Yello-Bowl®



Note: Strainer



### Model 01050288P20

20 gpm / 75.7 lpm Shower,  
Facewash with ABS Heads, &  
Wye, Drench Hose, Yello-Bowl®

### Model 01050288

30 gpm / 113.6 lpm Shower,  
Facewash with ABS Heads, &  
Wye, Drench Hose, Yello-Bowl®



Note: Drench Hose



### Model 01050290P20

20 gpm / 75.7 lpm Shower,  
Eyewash with ABS Heads &  
Wye, Foot Treadle, Yello-Bowl®

### Model 01050290

30 gpm / 113.6 lpm Shower,  
Eyewash with ABS Heads &  
Wye, Foot Treadle, Yello-Bowl®



Note: Foot Treadle



### Model 01050217P20PBC

20 gpm / 75.7 lpm Shower,  
Eyewash with Acetal Heads  
& BCP Wye, Plastic Bowl  
Cover, Yello-Bowl®

### Model 01050217PBC

30 gpm / 113.6 lpm Shower,  
Eyewash with Acetal Heads  
& BCP Wye, Plastic Bowl  
Cover, Yello-Bowl®



Note: Low profile Eyewash assembly



# Combination Showers Eyewash/Facewash

## Galvanized Piping

### Model 01050266P20PBC

20 gpm / 75.7 lpm Shower,  
Facewash with ABS Heads  
& BCP Wye, Strainer, Plastic  
Bowl Cover, Yello-Bowl®

### Model 01050266PBC

30 gpm / 113.6 lpm Shower,  
Facewash with ABS Heads  
& BCP Wye, Strainer, Plastic  
Bowl Cover, Yello-Bowl®



Note: Low profile BCP Wye assembly and  
Plastic bowl cover



### Model 01050230P20

20 gpm / 75.7 lpm Shower,  
Eyewash with Acetal Heads  
& BCP Wye, SS Bowl

### Model 01050230

30 gpm / 113.6 lpm Shower,  
Eyewash with Acetal Heads  
& BCP Wye, SS Bowl



Note: Stainless Steel Bowl



### Model 01050234P20

20 gpm / 75.7 lpm Shower,  
Facewash with ABS Heads &  
BCP Wye, SS Bowl

### Model 01050234

30 gpm / 113.6 lpm Shower,  
Facewash with ABS Heads &  
BCP Wye, SS Bowl



### Model 01050281P20

20 gpm / 75.7 lpm Shower,  
Eyewash with Acetal Heads  
& BCP Wye, SS Bowl, Foot  
Treadle

### Model 01050281

30 gpm / 113.6 lpm Shower,  
Eyewash with Acetal Heads  
& BCP Wye, SS Bowl, Foot  
Treadle



# Combination Showers Eyewash/Facewash

## Galvanized Piping

### Model 01050293P20

20 gpm / 75.7 lpm Shower,  
Facewash with ABS Heads  
& BCP Wye, SS Bowl, Foot  
Treadle

### Model 01050293

30 gpm / 113.6 lpm Shower,  
Facewash with ABS Heads  
& BCP Wye, SS Bowl, Foot  
Treadle



### Model 01050230P20PBC

20 gpm / 75.7 lpm Shower,  
Eyewash with Acetal Heads  
& BCP Wye, SS Bowl, Plastic  
Bowl Cover

### Model 01050230PBC

30 gpm / 113.6 lpm Shower,  
Eyewash with Acetal Heads  
& BCP Wye, SS Bowl, Plastic  
Bowl Cover



### Model 01050234P20PBC

20 gpm / 75.7 lpm Shower,  
Facewash with ABS Heads & BCP  
Wye, SS Bowl, Plastic Bowl Cover

### Model 01050234PBC

30 gpm / 113.6 lpm Shower,  
Facewash with ABS Heads & BCP  
Wye, SS Bowl, Plastic Bowl Cover



### Model 01050234P20SBC

20 gpm / 75.7 lpm Shower,  
Facewash with ABS Heads & BCP  
Wye, SS Bowl & Bowl Cover

### Model 01050234SBC

30 gpm / 113.6 lpm Shower,  
Facewash with ABS Heads & BCP  
Wye, SS Bowl & Bowl Cover



**Note:** Stainless Steel bowl with Plastic  
bowl cover



# Combination Showers Eyewash/Facewash

## Galvanized Piping

### Model 01050471S20SBC

20 gpm / 75.7 lpm SS  
Shower Head, Eyewash with  
Acetal Heads & BCP Wye,  
SS Bowl & Bowl Cover

### Model 01050471SBC

30 gpm / 113.6 lpm SS  
Shower Head, Eyewash with  
Acetal Heads & BCP Wye,  
SS Bowl & Bowl Cover



**Note:** Stainless Steel bowl and cover



### Model 01050221P20

20 gpm / 75.7 lpm Shower,  
Facewash with ABS Heads &  
Wye, No Bowl

### Model 01050221

30 gpm / 113.6 lpm Shower,  
Facewash with ABS Heads &  
Wye, No Bowl



**Note:** 8 gpm / 30.3 lpm Facewash  
assembly with no bowl



### Model 01050205P20

20 gpm / 75.7 lpm Shower,  
Eyewash with ABS Heads &  
Wye, No Bowl

### Model 01050205

30 gpm / 113.6 lpm Shower,  
Eyewash with ABS Heads &  
Wye, No Bowl



**Note:** 3.2 gpm / 12.1 lpm Eyewash  
assembly with no bowl



### Model 01050224P20

20 gpm / 75.7 lpm Shower,  
Facewash with ABS Heads &  
BCP Wye, No Bowl

### Model 01050224

30 gpm / 113.6 lpm Shower,  
Facewash with ABS Heads &  
BCP Wye, No Bowl

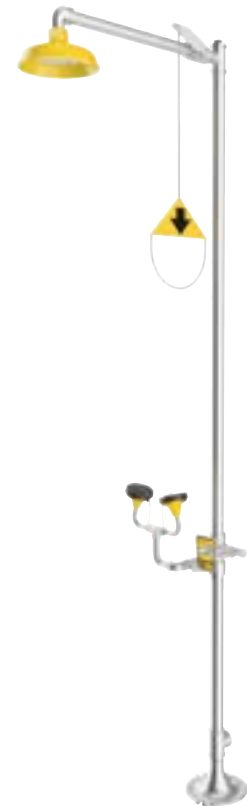

# Combination Showers Eyewash/Facewash

## Stainless Steel Piping

### PIPING AND VALVE CHOICES

- Schedule 40, 304 Stainless Steel piping
- Stainless Steel ball valves & ball

### SHIP WEIGHT

Shower — 59 lb / 26.76 kg

Shower with FTR — 61 lb / 27.66 kg

Shower with DH — 62 lb / 21.12 kg

### Model 01050219P20

20 gpm / 75.7 lpm Shower,  
Facewash with ABS Heads &  
Wye, Yello-Bowl®

### Model 01050219

30 gpm / 113.6 lpm Shower,  
Facewash with ABS Heads &  
Wye, Yello-Bowl®



### Model 01050223P20

20 gpm / 75.7 lpm Shower,  
Eyewash with ABS Heads &  
Wye, Yello-Bowl®

### Model 01050223

30 gpm / 113.6 lpm Shower,  
Eyewash with ABS Heads &  
Wye, Yello-Bowl®



### Model 01050232P20

20 gpm / 75.7 lpm Shower,  
Eyewash with Acetal Heads  
& BCP Wye, SS Bowl

### Model 01050232

30 gpm / 113.6 lpm Shower,  
Eyewash with Acetal Heads  
& BCP Wye, SS Bowl



**Note:** Every model in this section includes a 7" x 11" / 17.7 cm x 27.9 cm sign, part number 01112892. See signs on page 47.

# Combination Showers Eyewash/Facwash

## Stainless Steel Piping

### Model 01050236P20

20 gpm / 75.7 lpm Shower,  
Facewash with ABS Heads &  
BCP Wye, SS Bowl

### Model 01050236

30 gpm / 113.6 lpm Shower,  
Facewash with ABS Heads &  
BCP Wye, SS Bowl



### Model 01050236P20SBC

20 gpm / 75.7 lpm Shower,  
Facewash with ABS Heads & BCP  
Wye, SS Bowl, SS Bowl Cover

### Model 01050236SBC

30 gpm / 113.6 lpm Shower,  
Facewash with ABS Heads & BCP  
Wye, SS Bowl, SS Bowl Cover



### Model 01050264S20

20 gpm / 75.7 lpm SS  
Shower Head, Eyewash with  
SS Heads & Wye, SS Bowl

### Model 01050264

30 gpm / 113.6 lpm SS  
Shower Head, Eyewash with  
SS Heads & Wye, SS Bowl



### Model 01050470S20

20 gpm / 75.7 lpm SS  
Shower Head, Eyewash with  
SS Heads & Wye, SS Bowl,  
Foot Treadle

### Model 01050470

30 gpm / 113.6 lpm SS  
Shower Head, Eyewash with  
SS Heads & Wye, SS Bowl,  
Foot Treadle



Note: 2.5 gpm / 9.5 lpm Stainless  
Steel Eyewash assembly

# Combination Showers Eyewash/Facewash

## PVC Piping

### PIPING AND VALVE CHOICES

- Schedule 80 corrosion-resistant PVC piping with socket weld joints
- Corrosion-resistant coated bronze ball valves with chrome plated ball

### SHIP WEIGHT

Shower — 34 lb / 15.42 kg



### Model 01060022

20 gpm / 75.7 lpm Shower, Eyewash with ABS Heads & Wye, Yello-Bowl®, Free Standing

### Model 01060021

30 gpm / 113.6 lpm Shower, Eyewash with ABS Heads & Wye, Yello-Bowl®, Free Standing



**Note:** Supported overhead section for free-stand mounting.



**Note:** Every model in this section includes a 7" x 11" / 17.7 cm x 27.9 cm sign, part number 01112892. See signs on page 47.

### Model 01060007P20

20 gpm / 75.7 lpm Shower, Eyewash with ABS Heads & Wye, Yello-Bowl®, Wall Flange Support

### Model 01060007

30 gpm / 113.6 lpm Shower, Eyewash with ABS Heads & Wye, Yello-Bowl®, Wall Flange Support



### Model 01060009P20

20 gpm / 75.7 lpm Shower, Facewash with ABS Heads & Wye, Yello-Bowl®, Wall Flange Support

### Model 01060009

30 gpm / 113.6 lpm Shower, Facewash with ABS Heads & Wye, Yello-Bowl®, Wall Flange Support



# Combination Showers Eyewash/Facewash

## Corrosion-Resistant Coating

### PIPING AND VALVE CHOICES

- Schedule 80, hot dipped galvanized steel piping with high visibility yellow corrosion-resistant coating
- Chrome plated bronze ball valves & ball

### SHIP WEIGHT

Shower — 59 lb / 26.76 kg

### Model 01050276

20 gpm / 75.7 lpm Shower, Eyewash with ABS Heads & Wye, Yello-Bowl®

### Model 01050210

30 gpm / 113.6 lpm Shower, Eyewash with ABS Heads & Wye, Yello-Bowl®



### Model 01050277

20 gpm / 75.7 lpm Shower, Facewash with ABS Heads & Wye, Yello-Bowl®

### Model 01050228

30 gpm / 113.6 lpm Shower, Facewash with ABS Heads & Wye, Yello-Bowl®



### Model 01050376

20 gpm / 75.7 lpm Shower, Eyewash with ABS Heads & Wye, Yello-Bowl®, Foot Treadle

### Model 01050381

30 gpm / 113.6 lpm Shower, Eyewash with ABS Heads & Wye, Yello-Bowl®, Foot Treadle



**Note:** Every model in this section includes a 7" x 11" / 17.7 cm x 27.9 cm sign, part number 01112892. See signs on page 47.

# Combination Showers Eyewash/Facewash

## Vertical & Horizontal Showers

### PIPING

- Mounts directly onto overhead pipe
- Available with galvanized or stainless steel piping (standard ball valve included assembly with actuation graphic)

### SHIP WEIGHT

Horizontal Shower 1" / 2.5 cm supply — 8 lb / 3.62 kg

Vertical Shower 1" / 2.5 cm supply — 6 lb / 2.72 kg

Shower 1¼" / 3.2 cm supply — 11 lb / 4.98 kg



### Model 01052522

20 gpm / 75.7 lpm Shower, 1" / 2.5 cm Horizontal Pipe Mount

### Model 01052501

30 gpm / 113.6 lpm Shower, 1" / 2.5 cm Horizontal Pipe Mount



### Model 01052524

20 gpm / 75.7 lpm Shower, 1" / 2.5 cm Vertical Pipe Mount

### Model 01052502

30 gpm / 113.6 lpm Shower, 1" / 2.5 cm Vertical Pipe Mount



### Model 01053001P20

20 gpm / 75.7 lpm Shower, 1¼" / 3.2 cm Horizontal Pipe Mount

### Model 01053001

30 gpm / 113.6 lpm Shower, 1¼" / 3.2 cm Horizontal Pipe Mount



**Note:** Every model in this section includes a 7" x 11" / 17.7 cm x 27.9 cm sign, part number 01112891. See signs on page 47.



Encon® offers a complete line of **freeze-resistant showers and eyewash products** designed to **withstand subfreezing temperatures for brief periods**. Our freeze-resistant products utilize **temperature-sensitive valves** to circulate water during freezing periods and our **subsurface models** feature underground self-drain systems to **prevent freezing of exposed piping**.

- Schedule 80 hot dipped galvanized steel piping or schedule 40, 304 stainless steel piping
- Stay-open ball valves
- Stainless steel valve stems and actuators
- Actuation graphics
- Self-adjusting regulators
- Heads and Bowls available in high visibility yellow plastic or 304 stainless steel
- Eye and Facewash heads include hinged covers or float-off covers secured with stainless steel beads

#### **ACCESSORY OPTIONS AVAILABLE ON MOST MODELS**

- Bowl Cover: Available in yellow ABS plastic or 304 stainless steel
- Drench Hose for partial body flushing
- Step-on foot treadle for eye/facewash activation

# Freeze-Resistant Showers

## Freeze & Scald Protection Valves

### FREEZE & SCALD VALVE OPTIONS

- Freeze Protection Valve: Opens automatically when internal temperature reaches 35°F / 2°C and closes at 40°F / 4.5°C
- Scald Protection Valve: Opens automatically when internal temperature reaches 105°F / 40.6°C and closes at 94°F / 34.4°C

### SHIP WEIGHT

Automatic — 60 lb / 27.22 kg

### Model 01050362P20

20 gpm / 75.7 lpm Shower, Eyewash with ABS Heads & Wye, Auto. Freeze & Scald Protection Valves, Galvanized Pipe

### Model 01050362

30 gpm / 113.6 lpm Shower, Eyewash with ABS Heads & Wye, Auto. Freeze & Scald Protection Valves, Galvanized Pipe



### Model 01050317P20

20 gpm / 75.7 lpm Shower, Eyewash with ABS Heads & Wye, Auto. Freeze Protection Valve, Galvanized Pipe

### Model 01050317

30 gpm / 113.6 lpm Shower, Eyewash with ABS Heads & Wye, Auto. Freeze Protection Valve, Galvanized Pipe



Note: External drain temperature sensing valves



Note: Temperature sensing valve with drain back to pipe stanchion

### Model 01050314P20

20 gpm / 75.7 lpm Shower, Eyewash with ABS Heads & Wye, Auto. Freeze Protection Valve, Drench Hose, Galvanized Pipe

### Model 01050314

30 gpm / 113.6 lpm Shower, Eyewash with ABS Heads & Wye, Auto. Freeze Protection Valve, Drench Hose, Galvanized Pipe



Note: Drench hose



Note: Every model in this section includes a 7" x 11" / 17.7 cm x 27.9 cm sign, part number 01112892. See signs on page 47.



# Freeze-Resistant Showers

## Subsurface Showers & Eye/Facewash

### AUTOMATIC DRAIN

Water drains from exposed piping to help prevent freezing.

### SHIP WEIGHT

Subsurface Combination Shower — 115 lb / 52.16 kg

Subsurface Shower — 75 lb / 34.02 kg

Subsurface Eyewash — 40 lb / 18.14 kg

### Model FRSSC-GP20

20 gpm / 75.7 lpm Shower,  
Eyewash with ABS Heads &  
Wye, Galvanized Pipe

### Model FRSSC-G

30 gpm / 113.6 lpm Shower,  
Eyewash with ABS Heads &  
Wye, Galvanized Pipe

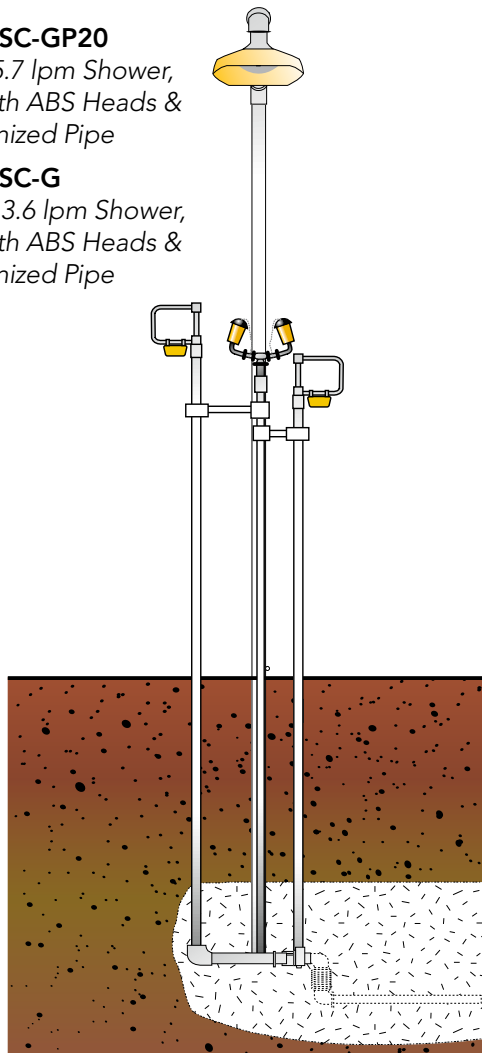

### Model 01050201P20

20 gpm / 75.7 lpm Shower,  
Galvanized Pipe

### Model 01050201

30 gpm / 113.6 lpm Shower,  
Galvanized Pipe

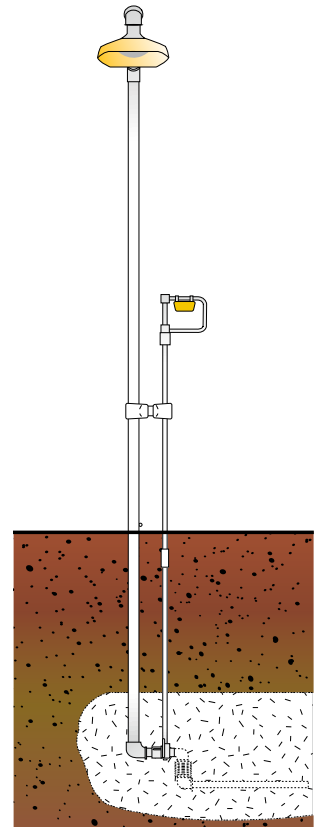

### Model 01030104

Eyewash with ABS Heads &  
Wye, Galvanized Pipe

### Model 01035604

Facewash, ABS Heads &  
Wye & Galvanized Pipe

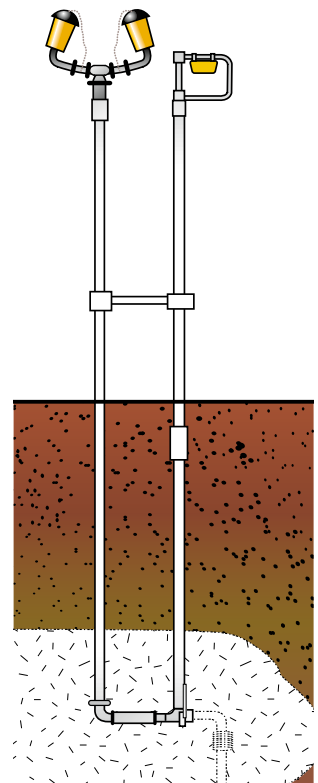

**Note:** Every model in this section includes a 7" x 11" / 17.7 cm x 27.9 cm sign, part number 01112892. See signs on page 47.

# Freeze-Resistant Showers

## Through-Wall Shower & Eyewash

### AUTOMATIC DRAIN

Water drains from exposed piping to help prevent freezing

### SHIP WEIGHT

Shower — 38 lb / 17.24 kg

Eye/Facewash — 9 lb / 4.08 kg

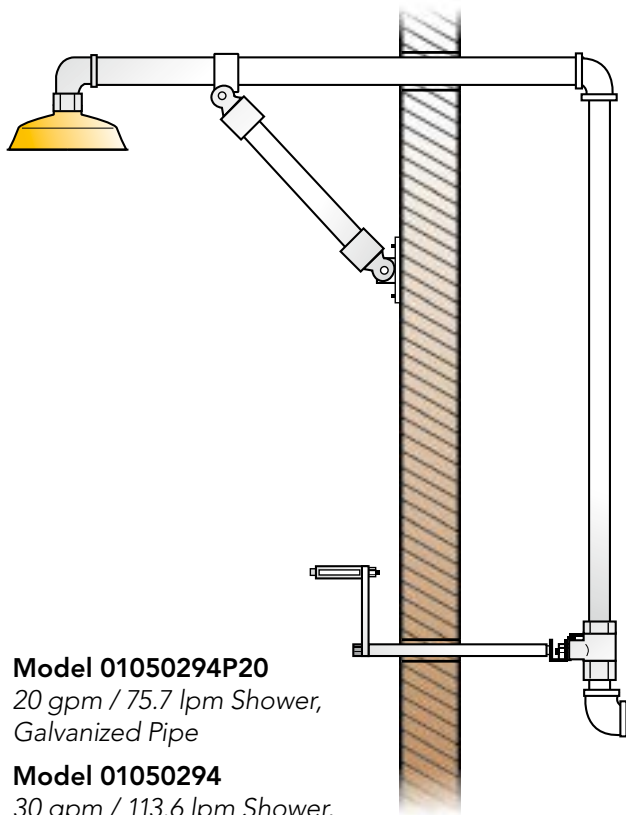

### Model 01050294P20

20 gpm / 75.7 lpm Shower,  
Galvanized Pipe

### Model 01050294

30 gpm / 113.6 lpm Shower,  
Galvanized Pipe

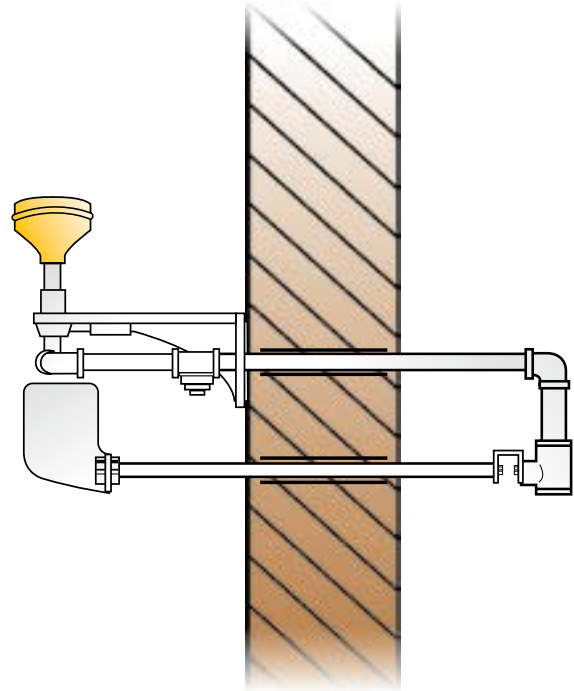

### Model 01035606

Facewash with ABS Heads,  
Wye & Galvanized Pipe

### Model 01030106

Eyewash, ABS Heads,  
Galvanized Pipe



**Note:** Every model in this section includes a 7" x 11" / 17.7 cm x 27.9 cm sign, part number 01112891. See signs on page 47.

**NOTE:** Allow minimum of 16" / 40.6 cm lateral clearance between shower and eyewash target areas for actuator arm movement.



**Extend your safety perimeter.** For areas where **plumbed potable water is not readily available**, Encon® offers a wide array of choices for self-contained emergency eyewash stations, including pressurized, gravity-fed, and sealed-cartridge units. Encon's self-contained eyewash stations meet **ANSI Z358.1-2014 requirements for emergency eyewash equipment**. Additionally, the Firststep® FirstFlush® station and the 5 Gallon / 22 Liter pressurized self-contained unit meet ANSI Z358.1-2014 standard for personal flushing equipment.

#### **GRAVITY FEDS**

- Durable Polyethylene body
- 0.4 gpm / 1.5 L ABS plastic dual-stream eyewash nozzles
- Pull-down tray for eyewash nozzle activation
- Instructions located on front graphics. Available in English, Spanish, and French/Canadian where noted
- CSA approved heated models with UL & FM components

#### **PRESSURIZED PORTABLES**

- 304 stainless steel ASME rated, CRN registered vessel
- ½" / 1.3 cm brass chrome-plated piping with stay-open ball valve
- Stainless steel valve stem and actuator
- Actuation graphics
- Self-adjusting regulator
- Brass relief valve opens at 115 PSI
- Custom face pressure gauge
- Drench Hose option available with self-closing, lock-open handle

#### **ACCESSORY OPTIONS AVAILABLE ON MOST MODELS**

- Insulating jacket and thermostat controlled heater
- Transport cart: Yellow tubular steel (gravity fed) or yellow polyethylene with strap (pressurized portable)
- Waste receptacle

# Self-Contained

## Aquarion®

The Aquarion® offers the sealed flexible cartridge that completely self-evacuates without external forces being applied, providing reliable performance when you need it most.

- High visibility yellow ABS removable cover
- Tinted translucent ABS side windows for internal visual inspection
- Black ABS base slides onto the Back Plate
- Gray retracting tray to protect the enclosed eyewash nozzles from the environment
- Preserved saline solution in individual bags

### SHIP WEIGHT

23 lb / 12.7 kg Unit

75 lb / 34.02 kg AQ120 fluid cartridges

37 lb / 16.78 kg AQ110 fluid cartridges

### TRANSPORT CART (Optional)

Yellow tubular steel with wheels

Weight — 66 lb / 22.94 kg

### WASTE RECEPTACLE (Optional)

Weight — 14 lb / 6.35 kg

## AQUARION®

**Model AQ120**  
*Preserved Saline Solution Fluid Cartridges\**

**Model AQ110**  
*Sterile Saline Solution Fluid Cartridges\*\**

**Model AQ111**  
*User Fillable Cartridges*



**Note:** \*Not available in Canada & Mexico  
\*\*Available only in Canada



**Model AQ100**  
*Aquarion® Self-Contained Eyewash*

**Model AQ100S**  
*Aquarion® Self-Contained Eyewash - Spanish*



**Model AQ100H130**  
*Heated Aquarion® Self-Contained Eyewash*

## Helios® Gravity Fed

Helios® has one of the sleekest profile of self-contained products available allowing simple installation and use in a tighter, smaller area close to facility hazards.

- High visibility yellow polyethylene tank
- Internal, rotating actuating valve integral to the eye wash tray
- Eyewash Heads inset directly into the black pull-down tray offering protection from airborne particulate
- Molded eyelet hangers for mounting
- Mounting bracket available. See page 51.

SHIP WEIGHT  
15 lb / 6.8 kg



**Model HS100**  
*Helios® Gravity Fed  
Eyewash - Spanish*

**Model HF100**  
*Helios® Gravity Fed  
Eyewash - French*



**Model HE100**  
*Helios® Gravity Fed  
Eyewash*



**Model 01110764**  
*A case reorder of  
Hydrosep® includes  
four 8 oz. / 236.6 mL  
bottles.*

# Self-Contained

## Gravity Fed

With its fillable tank design, the Self-Contained Gravity Fed has proven to be a reliable safety eyewash unit.

- High visibility yellow polyethylene tank; two carrying handles.
- Enclosed eyewash heads integral to hinged drain tray.

SHIP WEIGHT  
32 lb / 14.52 kg

TRANSPORT CART (Optional)  
Yellow tubular steel with wheels  
Weight — 66 lb / 22.94 kg

WASTE RECEPTACLE (Optional)  
Weight — 14 lb / 6.35 kg

**Model 01104070**  
*Hazardous Area  
C1D2 Gp. BCD  
Heated Gravity  
Fed Eyewash*



**Model 01104050**  
*Self-Contained Gravity  
Fed Eyewash*

**Model 01104050S**  
*Self-Contained Gravity  
Fed Eyewash - Spanish*

**Model 01104050C**  
*Self-Contained Gravity  
Fed Eyewash - French*



**Model 01104055**  
*Gravity Fed  
Eyewash with  
Transport Cart and  
Waste Receptacle*

**Model 00015006**  
*Receptacle Lid*

## Standard Pressurized Portable Eyewash

The large water fill opening, convenient air fill stem and customized fill indicator pressure gauge makes the standard pressurized portables easy to maintain.

- 13 Gallon / 57.2 Liter capacity; ASME, Div. VIII, Section 1 rated, and CRN registered vessel
- Heated option maintained at a temperature between 60-90°F / 15.5-32.2°C

### SHIP WEIGHT

32 lb / 14.52 kg

34 lb / 15.42 kg with Drench Hose

### YELLOW CART (Optional)

Yellow polyethylene w/wheels & strap

Weight — 26.8 lb / 12.16 kg

### Model 01103004

13 Gallon / 57.2 Liter,  
Socket Mount Eyewash  
with 8' / 2.4 m Hose,  
Heated 120 VAC

### Model 01103006

13 Gallon / 57.2 Liter,  
Socket Mount Eyewash  
with 8' / 2.4 m Hose,  
Heated 120 VAC, C1D2 Gr.  
BCD



### Model 01104002

13 Gallon / 57.2 Liter,  
Fixed Eyewash with  
handheld 8' / 2.4 m  
Drench Hose

### Model 01103002

13 Gallon / 57.2 Liter,  
Socket Mount Eyewash  
with 8' / 2.4 m Hose



### Model 01103008

Transport cart only  
(Eyewash station  
not included)



# Self-Contained

## Large Pressurized Portable Eyewash

The large 37 Gallon / 162.9 Liter tank allows you the freedom to set up a dependable pressurized eyewash and drench station where you need it most.

- 37 Gallon / 162.9 Liter is ASME, Div. VIII, Section 1 rated, and CRN registered vessel

SHIP WEIGHT  
160 lb / 72.6 kg

DOLLY CART  
Green tubular steel with wheels and retaining chains  
Weight — 30 lb / 13.61 kg

**Model 01106002**  
37 Gallon / 162.9  
Liter Eyewash &  
Drench Hose



**Model 01106001**

37 Gallon / 162.9 Liter Eyewash with Drench Hose & Dolly cart



**Model 01106004**  
37 Gallon / 162.9 Liter  
Eyewash with Drench  
Hose, Insulation &  
Heat Reflective Jacket





## Personal Flushing Stations

### Firststep® Firstflush®

- 32 oz. / 946 mL Sterile buffered isotonic saline solution
- Highly visible yellow ABS plastic holder with operational instructions; vibration and UV resistant
- HDPE, durable, non-resealable bottle

### SHIP WEIGHT

Single — 20 lb / 9.07 kg

Dual — 20 lb / 9.07 kg

### Personal Pressurized Portable

- 5 Gallon / 22 Liter capacity; 25" x 8¼" / 63 cm x 21 cm with carrying handles

### SHIP WEIGHT

15 lb / 6.8 kg

### Model 01103001

5 Gallon / 22 Liter Personal Pressurized Portable, Socket Mount Nozzles, 8' / 2.4 m Coil Hose



### Model 01110786S

Firststep® FirstFlush® Single Station Units

### Model 01110793S

Firststep® FirstFlush® Dual Station Units



### Model 01101001

5 Gallon / 22 Liter Personal Pressurized Portable, 8' / 2.4 m Coiled Drench Hose





**The Eyewash & Facewash station** is most appropriate in areas where **hazards to the eyes and face** are most common. Our Eyewash & Facewash units are designed for ease of installation to your facility's **plumbed water supply**. We offer **installation options to a wall, a supply-pipe, or a pedestal** to facilitate installations nearest to those areas where exposure can occur. **Don't forget a bowl cover to keep dirt and debris away from the eye/facewash.**

- 1/2" / 1.3 cm Stay-open ball valve
- Stainless steel valve stem and Push Plate actuator
- Actuation graphics
- Self-adjusting regulator
- Heads and Bowls available in high visibility yellow plastic or 304 stainless steel
- Eye and Facewash heads include hinged covers or float-off covers secured with stainless steel beads
- 1/2" / 1.3 cm NPT Supply connection

#### **ACCESSORY OPTIONS AVAILABLE ON MOST MODELS**

- **Bowl Cover:** Available in yellow ABS plastic or 304 stainless steel. Cover is opened by push plate and manually closed.
- **Drench Hose:** For partial body flushing. 6' / 1.8 m synthetic rubber hose assembly, mounting bracket, yellow ABS single stream head with float-off cover, self-closing lock-open squeeze handle actuator.
- **Foot Treadle:** Yellow ABS plastic step-on treadle with stainless steel chain for eye/facewash activation.

# Eyewash & Facewash

## Wall Mount

### BOWL WASTE CHOICES

- Yello-Bowl® — 1¼" x 6" / 3.2 cm x 15.2 cm slip joint tailpiece
- 304 SS Bowl — 1¼" / 3.2 cm NPT connection
- P-trap — 1¼" / 3.2 cm tube connection

### SHIP WEIGHT

Wall Mount SS Bowl — 9 lb / 4.08 kg

Wall Mount Yello-Bowl® — 6 lb / 2.72 kg



### Model 01030403

Eyewash, ABS Heads & Wye, Yello-Bowl®, Wall Bracket, BCP Pipe & Valve, Strainer

### Model 01035503

Facewash, ABS Heads & Wye, Yello-Bowl®, Wall Bracket, BCP Pipe & Valve, Strainer



Note: Strainer



### Model 01030401

Eyewash, ABS Heads and Wye, BCP Pipe & Valve, Yello-Bowl®, Wall Bracket

### Model 01035501

Facewash, ABS Heads and Wye, BCP Pipe & Valve, Yello-Bowl®, Wall Bracket



### Model 01030416

Eyewash, Acetal Heads, BCP Wye, Yello-Bowl®, Wall Bracket, BCP Pipe & Valve, Strainer

### Model 01035511

Facewash, ABS Heads, BCP Wye, Yello-Bowl®, Wall Bracket, BCP Pipe & Valve, Strainer



Note: 2.4 gpm / 9.1 lpm Acetal eyewash heads. Bowl covers are available on models with BCP Wye. See bowl covered model on page 28.



Note: Every model in this section includes a 7" x 11" / 17.7 cm x 27.9 cm sign, part number 01112893. See signs on page 47.

# Eyewash & Facewash

## Wall Mount



**Model 01045001**  
Eyewash, Acetal Heads & BCP  
Wye, BCP Pipe & Valve, SS  
Bowl, Wall Bracket

**Model 01045501**  
Facewash, ABS Heads & BCP  
Wye, BCP Pipe & Valve, SS  
Bowl, Wall Bracket



**Model 01045001PBC**  
Eyewash, Acetal Heads, BCP  
Wye, SS Bowl, Plastic Bowl  
Cover, Wall Bracket

**Model 01045501PBC**  
Facewash, ABS Heads, BCP  
Wye, SS Bowl, Plastic Bowl  
Cover, Wall Bracket



**Model 01045501SBC**  
Facewash, ABS Heads & Low  
Profile BCP Wye, BCP Pipe &  
Valve, SS Bowl & Cover, Wall  
Bracket

**Model 01045001SBC**  
Eyewash, Acetal Heads, BCP  
Wye, SS Bowl & Bowl Cover,  
Wall Bracket



**Model 01045010**  
Eyewash, Acetal Heads, BCP  
Wye, SS Bowl, Wall Bracket,  
BCP Pipe & Valve, P-Trap

**Model 01045510**  
Facewash, ABS Heads, BCP  
Wye, SS Bowl, Wall Bracket,  
BCP Pipe & Valve, P-Trap

# Eyewash & Facewash

## Supply Pipe Mount

### BOWL WASTE CHOICES

- Yello-Bowl® — 1¼" x 6" / 3.2 cm x 15.2 cm slip joint tailpiece
- 304 SS Bowl — 1¼" / 3.2 cm tube connection

### SHIP WEIGHT

- Supply Mount Yello-Bowl® — 6 lb / 2.72 kg
- Supply Mount SS Bowl — 9 lb / 4.08 kg



### Model 01045505

Facewash, ABS Heads & BCP Wye, BCP Pipe & Valve, SS Bowl

### Model 01045005

Eyewash, Acetal Heads, BCP Wye, SS Bowl, BCP Pipe & Valve



### Model 01030301

Eyewash, ABS Heads & Wye, BCP Pipe & Valve, Yello-Bowl®

### Model 01035401

Facewash, ABS Heads & Wye, BCP Pipe & Valve, Yello-Bowl®



### Model 01038301

Eyewash, ABS Heads & Wye, Yello-Bowl®, PVC Pipe & Valve

### Model 01038801

Facewash, ABS Heads & Wye, Yello-Bowl®, PVC Pipe & Valve



**Note:** Every model in this section includes a 7" x 11" / 17.7 cm x 27.9 cm sign, part number 01112893. See signs on page 47.

# Eyewash & Facewash

## Supply Pipe Mount



**Model 01035601**  
Facewash, ABS Heads  
& Wye, No Bowl, BCP  
Pipe & Valve

**Model 01030101**  
Eyewash, ABS Heads  
& Wye, No Bowl, BCP  
Pipe & Valve



**Model 01035603**  
Facewash, ABS Heads  
& Wye, No Bowl, BCP  
Pipe & Valve, Strainer

**Model 01030103**  
Eyewash, ABS Heads  
& Wye, No Bowl, BCP  
Pipe & Valve, Strainer



**Model 01045601**  
Facewash, ABS Heads &  
BCP Wye, No Bowl, BCP  
Pipe & Valve

**Model 01040103**  
Eyewash, Acetal Heads,  
BCP Wye, No Bowl, BCP  
Pipe & Valve



**Model 01040135**  
Eyewash, SS Heads & Wye,  
No Bowl, SS Pipe & Valve

**Model 01114021**  
Facewash, SS Heads & Wye,  
No Bowl, SS Pipe & Valve

# Eyewash & Facewash

## Pedestal Mount

Schedule 80 galvanized pedestal.

### WASTE

- 1¼" / 3.2 cm NPT connection

### SHIP WEIGHT

Pedestal Mount — 25 lb / 11.34 kg

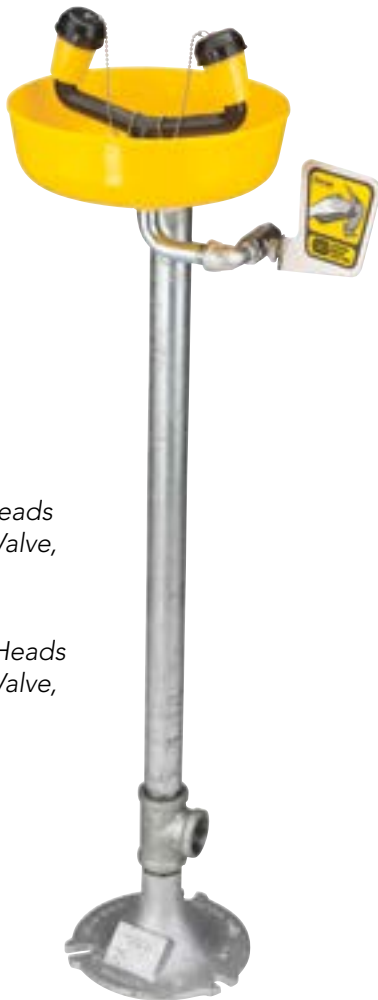

### Model 01030302

*Eyewash with ABS Heads & Wye, BCP Pipe & Valve, Yello-Bowl®*

### Model 01035402

*Facewash with ABS Heads & Wye, BCP Pipe & Valve, Yello-Bowl®*

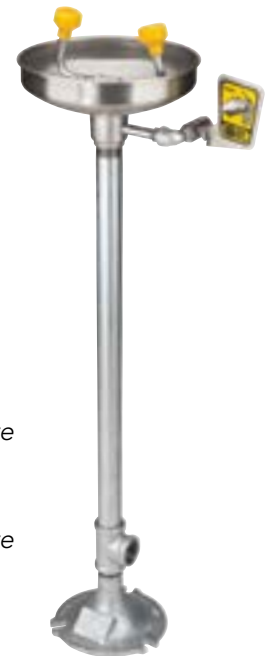

### Model 01045002

*Eyewash, Acetal Heads, BCP Wye, SS Bowl, BCP Pipe & Valve*

### Model 01045502

*Facewash, ABS Heads, BCP Wye, SS Bowl, BCP Pipe & Valve*



### Model 01045002SBC

*Eyewash, Acetal Heads, BCP Wye, SS Bowl & Bowl Cover, BCP Pipe & Valve*

### Model 01045502SBC

*Facewash, ABS Heads, BCP Wye, SS Bowl & Bowl Cover, BCP Pipe & Valve*



**Note:** Every model in this section includes a 7" x 11" / 17.7 cm x 27.9 cm sign, part number 01112893. See signs on page 47.

# Eyewash & Facewash

## Pedestal Mount



**Model 01030316PBC**  
Eyewash, Acetal Heads,  
BCP Wye, Yello-Bowl®,  
Plastic Bowl Cover, BCP  
Pipe & Valve

**Model 01035415PBC**  
Facewash, ABS Heads,  
BCP Wye, Yello-Bowl®,  
Plastic Bowl Cover, BCP  
Pipe & Valve



**Model 01045006**  
Eyewash, Acetal Heads,  
BCP Wye, SS Bowl,  
BCP Pipe & Valve, Foot  
Treadle

**Model 01045506**  
Facewash, ABS Heads,  
BCP Wye, SS Bowl,  
BCP Pipe & Valve, Foot  
Treadle



**Model 01045008**  
Eyewash, Acetal Heads,  
BCP Wye, SS Bowl, BCP  
Pipe & Valve, Strainer

**Model 01045514**  
Facewash, ABS Heads,  
BCP Wye, SS Bowl, BCP  
Pipe & Valve, Strainer



**Model 01035410**  
Facewash, ABS Heads  
& Wye, Yello-Bowl®,  
BCP Pipe & Valve,  
Drench Hose

**Model 01030310**  
Eyewash, ABS Heads &  
Wye, Yello-Bowl®, BCP  
Pipe & Valve, Drench  
Hose



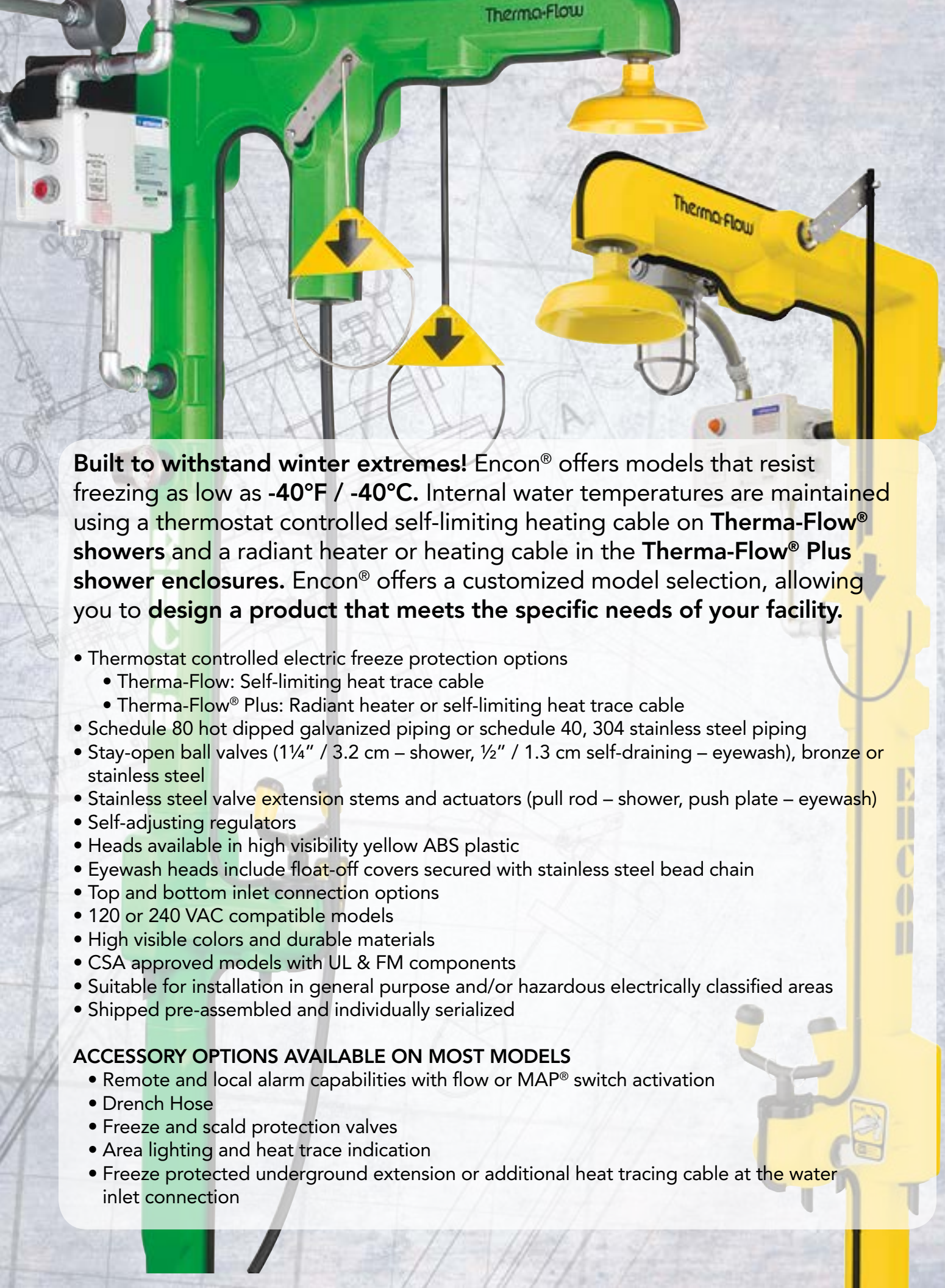

**Built to withstand winter extremes!** Encon® offers models that resist freezing as low as **-40°F / -40°C**. Internal water temperatures are maintained using a thermostat controlled self-limiting heating cable on **Therma-Flow® showers** and a radiant heater or heating cable in the **Therma-Flow® Plus shower enclosures**. Encon® offers a customized model selection, allowing you to **design a product that meets the specific needs of your facility**.

- Thermostat controlled electric freeze protection options
  - Therma-Flow: Self-limiting heat trace cable
  - Therma-Flow® Plus: Radiant heater or self-limiting heat trace cable
- Schedule 80 hot dipped galvanized piping or schedule 40, 304 stainless steel piping
- Stay-open ball valves (1¼" / 3.2 cm – shower, ½" / 1.3 cm self-draining – eyewash), bronze or stainless steel
- Stainless steel valve extension stems and actuators (pull rod – shower, push plate – eyewash)
- Self-adjusting regulators
- Heads available in high visibility yellow ABS plastic
- Eyewash heads include float-off covers secured with stainless steel bead chain
- Top and bottom inlet connection options
- 120 or 240 VAC compatible models
- High visible colors and durable materials
- CSA approved models with UL & FM components
- Suitable for installation in general purpose and/or hazardous electrically classified areas
- Shipped pre-assembled and individually serialized

#### **ACCESSORY OPTIONS AVAILABLE ON MOST MODELS**

- Remote and local alarm capabilities with flow or MAP® switch activation
- Drench Hose
- Freeze and scald protection valves
- Area lighting and heat trace indication
- Freeze protected underground extension or additional heat tracing cable at the water inlet connection

# Freeze-Protected Showers

## Therma-Flow<sup>®</sup> Freeze-Protected Showers

- Shower piping is heat traced and insulated, and includes high visibility covers
- Freeze protected to -40°F / -40°C in most applications
- Covers are field removable for field maintenance



### Model TF35B5376300

20 gpm / 75.7 lpm Shower, Eyewash, C1D2 Gp. BCD, Green Area Light, Heat Trace Indicator, Freeze & Scald Protection Valves, Red Alarm Light & Horn, MAP<sup>®</sup> Switch, Yellow covers



### Model TF36B2000302

20 gpm / 75.7 lpm Shower, Eyewash, C1D2 Gp. BCD, Heat Trace Indicator, MAP<sup>®</sup> Switch, Remote Alarm, Green covers



### Model TF34B2300001

20 gpm / 75.7 lpm Shower, Eyewash, C1D2 Gp. BCD, Heat Trace Indicator, Freeze & Scald Protection Valves, Orange covers



**Note:** Every model in this section includes a 16½" x 6" / 41.1 cm x 15.2 cm sign, part number 35001810. See signs on page 46.

# Freeze-Protected Showers

## CUSTOM DESIGN YOUR THERMA-FLOW® SYSTEM

Create your model to meet the specific needs of your facility.

Position 3 ELEC. CLASS / VOLTAGE	Position 5 DELIVERY SYSTEM	Position 7 SAFETY VALVES & THERMOMETER	Position 9 LIGHT COLORS	Position 11 UNDERGROUND EXTENSION & EXTRA CABLE
1 - NEMA 4 / 120V	A - 30 gpm / 113.6 lpm Shower, EW	0 - None	0 - None	0 - None
2 - NEMA 4 / 240V	B - 20 gpm / 75.7 lpm Shower, EW	1 - Freeze Protection Valve	1 - One Light Only - Clear	1 - 2' / 0.6 m Underground Extension
3 - Class 1 Div. 2, Gp. B,C,D / 120V; Class 2 Div. 2, Gp. F & G	D - 30 gpm / 113.6 lpm Shower, EW, DH	2 - Scald Protection Valve	2 - One Light Only - Red	2 - 2½' / 0.8 m Underground Extension
4 - Class 1 Div. 2, Gp. B,C,D / 240V; Class 2 Div. 2, Gp. F & G	E - 20 gpm / 75.7 lpm Shower, EW, DH	3 - Freeze & Scald Protection Valves	3 - One Light Only - Green	3 - 3' / 0.9 m Underground Extension
* Class 1, Div. 1 Gp. D option is available on some models. Price on application.	H - 30 gpm / 113.6 lpm Shower, DH	4 - Thermometer	4 - One Light Only - Blue	4 - 3½' / 1.1 m Underground Extension
	J - 20 gpm / 75.7 lpm Shower, DH	5 - Thermometer / Freeze Protection Valve	5 - Area Light - Clear Alarm Light - Red	5 - 4' / 1.2 m Underground Extension
	EW = Eyewash DH = Drench Hose	6 - Thermometer / Scald Protection Valve	6 - Area Light - Green Alarm Light - Red	A - 10' / 3 m Heating Cable
		7 - Thermometer / Freeze & Scald Protection Valves	7 - Area Light - Blue Alarm Light - Red	B - 20' / 6.1 m Heating Cable
				C - 30' / 9.1 m Heating Cable
				D - 40' / 12.2 m Heating Cable
				E - 50' / 15.2 m Heating Cable
<b>T</b> <b>F</b> <input type="checkbox"/> <input type="checkbox"/>	<input type="checkbox"/> <input type="checkbox"/>	<input type="checkbox"/> <input type="checkbox"/>	<input type="checkbox"/> <input type="checkbox"/>	<input type="checkbox"/> <input type="checkbox"/>
Position 4 WATER INLET	Position 6 AREA LIGHT & CONTROLS	Position 8 ALARM SYSTEM	Position 10 ALARM ACTIVATION	Position 12 COVER COLOR
0 - 1¼" / 3.2 cm Top	0 - None	0 - Not Required	0 - None	0 - Yellow
2 - 1¼" / 3.2 cm Bottom	1 - Side Area Light	1 - Light	1 - Flow Switch Top Connection	1 - Orange
4 - 1½" / 3.8 cm Top	2 - Heat Trace Indicator	2 - Bell	2 - Flow Switch Bottom Connection	2 - Green
5 - 1½" / 3.8 cm Bottom	3 - Top Area Light	3 - Piezo Annunciator	3 - MAP® Switch Shower, EW	
6 - 1½" / 3.8 cm Top & Bottom*	4 - Side Area Light / Heat Trace Indicator	4 - Horn	4 - MAP® Switch Shower, DH	
*Top & Bottom water inlet requires special design and model number if extra cable is required. Top & Bottom inlet locations can cause undesired alarm activation if Flow Switch is the selected alarm activation method.	5 - Top Area Light / Heat Trace Indicator	5 - Light / Bell	5 - MAP® Switch Shower, EW, DH	
		6 - Light / Piezo Annunciator		
		7 - Light / Horn		

### NOTES:

Position 8 - Options 3,6: The piezo annunciator (intermittent signal) is suitable for electrical classification up to Class 1 Div. 2 Gp. B only, not for use in

Class 1, Div. 1 applications. Includes reset button on audible alarm.  
Position 11 - Underground Extension dimensions references length of pipe below grade.

# Freeze-Protected Showers

## Therma-Flow® PLUS Freeze-Protected Shower Enclosures

- Fully enclosed shower and eyewash
- Freeze protection provided by internal radiant heater or Therma-Flow® shower and eyewash
- Enclosure includes fire-retardant fiberglass reinforced plastic and urethane foam walls, chemical resistant UV inhibited gel coat finish, and adjustable double swinging doors with weather seals



### Model TP21323230

Therma-Flow® 20 gpm / 75.7 lpm Shower, Eyewash, C1D2 Gp. BCD, Drench Hose, Red Lights & Bell, Green Area Light, Room Heater, Flow Switch

Fountain  
Section  
detail



Overhead  
Section  
detail



# Freeze-Protected Showers

## CUSTOM DESIGN YOUR SYSTEM

Create your model to meet the specific needs of your facility.

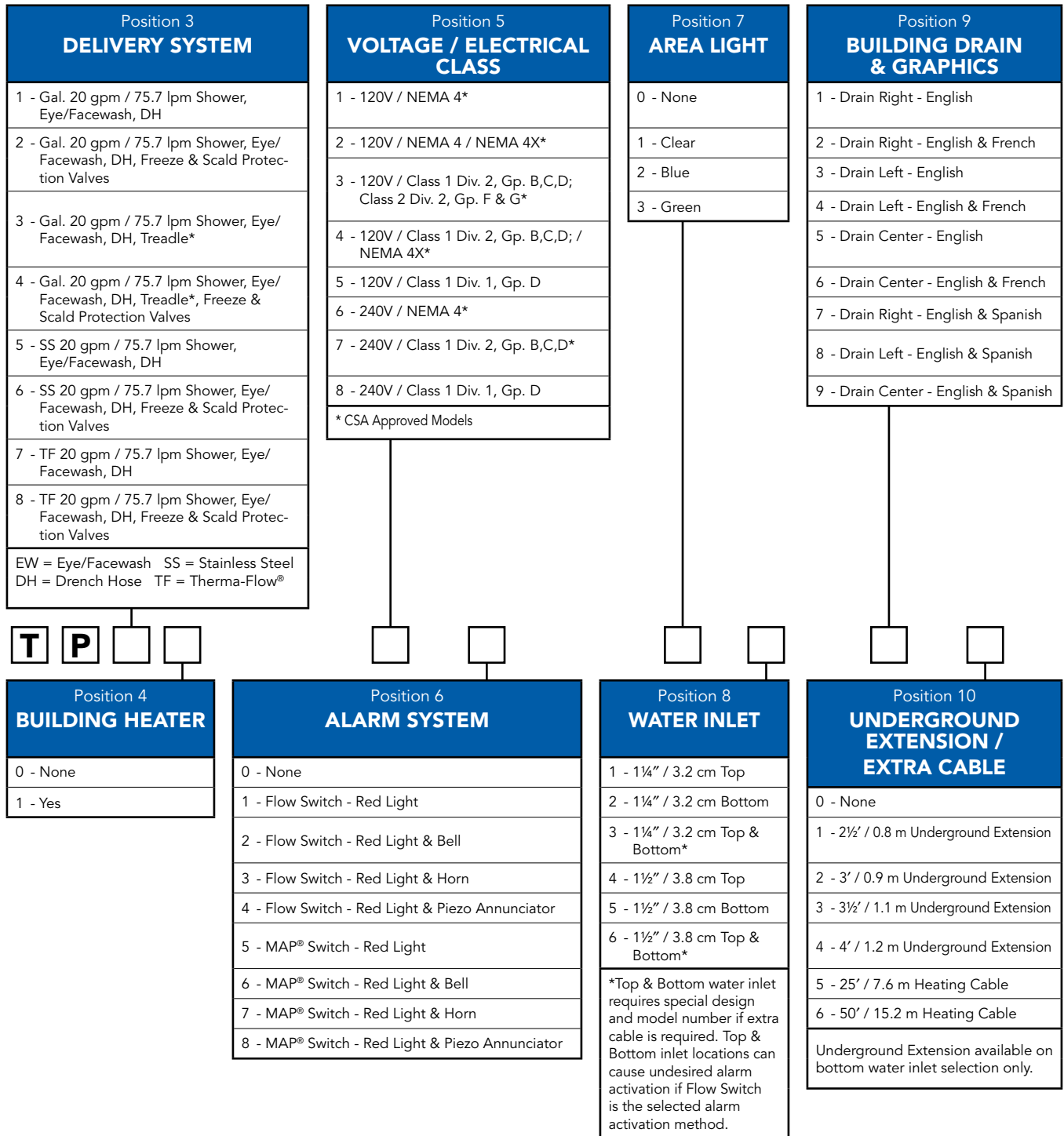

### NOTES:

Position 3 - \*Foot Treadle shall activate Eye/Facewash only.

Position 6 - Options 4, 8: The piezo annunciator (intermittent signal) is suitable for electrical classification up to Class

1 Div. 2 Gp. B only, not for use in Class 1, Div. 1 applications. Includes reset button on audible alarm.

Position 10 - Underground Extension dimensions references length of pipe below grade.



**Tempered Water Systems from Encon®** are deployed all over the world, from the frigid Canadian Oil Sands, to the salt-water soaked North Sea Oil Platforms, and in the scorching heat of the Texas Gulf Coast. Our systems are custom built and designed to provide water at temperatures and flow levels consistent with current **requirements for tepid potable water**. The central element of our tempered water systems is a blending system that is used to manage tepid water delivery and **developed with fail-safe mechanisms** for use in emergency shower and eyewash equipment. Our systems are **turnkey delivered** to the specific needs of your facility and can be optioned for electrical or steam heated water and then blended and driven with the addition of electrical water pumps or pressurized air if required.

- Systems provide tempered water according to standard requirements
- Various tempering and delivery system options available
- Fail-safe designs
- Indoor and freeze-protected outdoor models
- Schedule 80 hot dipped galvanized piping
- Available with shower and eyewash station included, or without to provide tempered water to separate stations in the facility loop
- Suitable for installation in general purpose and hazardous electrically classified areas
- CSA approved models with FM, UL, and CSA approved components
- Custom ordering system
- Ships pre-assembled and individually serialized

#### **OPTIONS AVAILABLE ON MOST MODELS**

- Freeze protection by thermostat controlled radiant heater for enclosed models
- Various local and remote alarm capabilities and alarm activation devices
- Custom engineered pump packages
- Corrosion-resistant coating for exposed piping and metal components
- High visibility color and signage options
- Area lighting
- Freeze-protected underground extension at the water inlet connection

# Tempered Water Systems

## Electrically Heated & Blended

- 120 Gallon, 30 gpm / 454.2 Liter, 113.6 lpm blending or 300 Gallon, 60 gpm / 1135.6 Liter, 227.1 lpm blending models
- Water delivered from electrically heated vessel and mixed with cold water through electrically controlled fail-safe blending system
- Target 85°F / 29.4°C outlet water
- Plumbed from local facility cold water supply

### Custom Design Your System

Create your model to meet the specific needs of your facility



300 Gallon, 60 gpm / 1135.6 liter, 227.1 lpm electric blending system, Dual recirculation and booster pumps, skid mounted



120 Gallon, 30 gpm / 454.2 liter, 113.6 lpm electric blending system, Yellow corrosion-resistant coating, alarm, skid mounted

# Tempered Water Systems

## Air Driven

- 400 Gallon / 1514.2 Liter self-contained system
- Designed for areas where plumbed potable water is not always available
- Water delivered from electrically heated vessel at pressure supplied from compressed air cylinders, facility instrument or clean utility air
- Treated water stored at 85°F / 29.4°C
- Uses water from portable transport, temporary supply, or plumbed lines with insufficient volume and pressure

## Custom Design Your System

Create your model to meet the specific needs of your facility

*Air Driven 400 Gallon / 1514.2 Liter, Blue enclosure, Alarm Light and Horn*



*Air driven 400 Gallon / 1514.2 Liter, Shower & Eyewash, Grey corrosion-resistant coating, Stainless Steel Eyewash Bowl, Heat reflective tank cover, skid mounted*



*Air driven 400 Gallon / 1514.2 Liter, Horizontal tank, Stainless Steel Shower and Eyewash heads, Alarm Light and Horn*



**01110802**  
32 oz. / 946.4 mL  
Hydrosep® included  
with air-driven unit.  
Reorder in case of  
12. See page 51.

**Wondering if customization is right for you?  
Call Encon Customer Service Representative with your  
questions or to place an order at 1-800-283-6266.**



# Tempered Water Systems

## Steam Heated & Blended

- Water heated and delivered through a steam heat exchanger and mixed with cold water through a blending valve
- Redundant blending system included for fail-safe operation
- Target 85°F / 29.4°C outlet water
- Plumbed from local facility cold water supply and facility steam source

### Custom Design Your System

Create your model to meet the specific needs of your facility



Steam heating, 60 gpm / 227.1 lpm  
Electric Blending System, Dual  
Recirculation Pumps, Single Booster  
Pump, Yellow enclosure

Wondering if customization is right for you? Call Encon Customer Service Representative with your questions or to place an order at 1-800-283-6266.

# Fail-Safe Blending

## Saf-T-Flo® Fail-Safe Blending

- 30 and 60 gpm / 113.6 and 227.1 lpm models
- Target 85°F / 29.4°C outlet water
- Redundant solenoid valves for tempering control
- Fail-safe to cold-water bypass
- Temperature gauge included
- 120 or 240 VAC compatible models
- Bracket or corrosion-resistant case for wall mounting
- Heated wall case option available

### PIPING CHOICES

- Galvanized with brass valves
- Polyurethane coated galvanized pipe and brass valves
- Copper with brass valves
- Stainless steel with stainless steel valves (available for 30 gpm / 113.6 lpm units only)

### Model STF30WB120G

30 gpm / 113.6 lpm, Wall Bracket, Galvanized Pipe, Brass Valves, 120V



### Model

### STF60WB120G

60 gpm / 227.1 lpm, Wall Bracket, Galvanized Pipe, Brass Valves, 120V

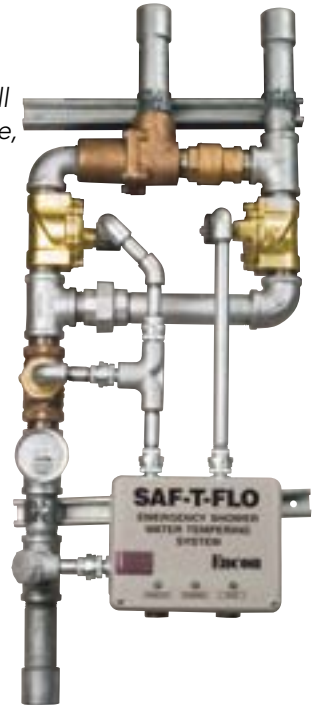

### Model STF30WP120C

30 gpm / 113.6 lpm, Wall Case, Copper Pipe, Brass Valves, 120V

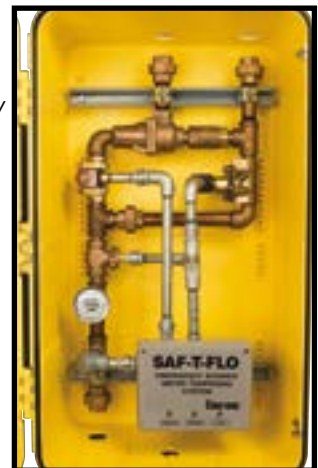

## Alarm Systems & Lighting

STANDARD IN ALL SYSTEMS

### Installation

For existing or new Shower stations to alert local and/or remote locations when in use

### Remote Capability

Spare NO/NC "dry" contacts available on all alarm products; 120V, 3 amp rating on relay remote

### WALL/SHOWER MOUNT

- NEMA 3 rated
- Displays red blinking alarm light and rings bell when activated

### SHOWER MOUNT OPTIONS

#### Light & Audio Alarm with Reset Switch

- Provides intermittent pulsing signal when activated; local reset button to silence the audible alarm

#### Visual Alarm

- Displays red blinking alarm light when activated

#### Area Light

- Provides constant illumination to emergency station when area vision is compromised; choice of clear, blue or green globe light

### ACTIVATION DEVICE OPTIONS

#### Flow Switch\*

- Detects flow through piping when emergency assembly activated; suitable for Class 1 Div. 2 Gp. B, C & D areas

#### MAP® Switch (Magnetic Activated Proximity Switch)

- Senses shower pull rod and/or push plate activation; Yello-Bowl®, SS bowl, or no bowl options available



**Model 01052155**  
Wall/Shower Mount, Audio/Visual Alarm, Flow Switch

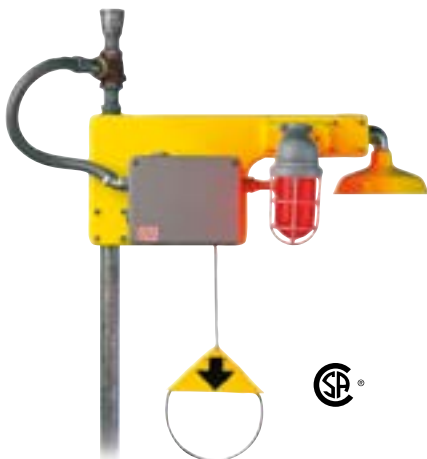

**Model 02111000**  
Audible Alarm, Red Alarm Light, contacts for remote, Flow Switch

### Shower Mount Model Number Generator

	Activation Device	Audible Alarm	Visual Alarm	Area Light
No	0	No 0	No 0	No 0
Flow Switch	1	Yes 1	Yes 1	Yes Clear Globe 1
MAP® Switch for Yello-Bowl® & No Bowl Models	2			Yes Blue Globe 2
MAP® Switch for Stainless Steel Bowl Models	3			Yes Green Globe 3

Model #: 02- \_\_\_ - \_\_\_ - \_\_\_ - \_\_\_ -00

\*Flow switch systems include flexible conduit for top water entry systems. Midpoint or lower-water entry systems require additional conduit and field assembly by others.

# Accessories and Parts

## Alarm Systems & Lighting



**Model 02200000**  
Remote alarm contacts only, MAP®  
switch

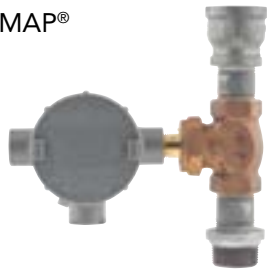

**Model 02100000**  
Remote alarm contacts only, flow switch

**Model 02000200**  
Area Light only, blue



**Model 02000300**  
Area Light only, green



**Model 02211300**  
Audible Alarm, Red Alarm Light, remote  
contacts, MAP® switch, Green Area Light



**Model 02311000 240**  
Audible Alarm, Red Alarm Light, remote  
contacts, MAP® switch

## AWARENESS 100™ Signage

High visibility graphics and reflective strip on chemical resistant ABS plastic shell.

### MOUNTING CHOICES

- Pipe Mount  
Includes plastic snap rivets for easy and secure mounting on piping stanchion.
- Wall Mount  
Suitable for wall mounting above fountains or below shower (hardware not included).

### GRAPHIC CHOICES

- Shower/Eyewash Icons
- Shower/Shower Icons
- Eyewash/Eyewash Icons

### DIMENSIONS

- 6½" x 4" x 20" / 16.5 cm x 10.1 cm x 50.8 cm

### SHIP WEIGHT

- 5 lb / 2.27 kg



**Model 00113003**  
AWARENESS 100™ Sign  
Orange, Black Shower/Shower, Pipe Mount

**Model 00113000**  
AWARENESS 100™ Sign  
Yellow, Black Shower/Shower, Pipe Mount

**Model 00113006**  
AWARENESS 100™ Sign  
Green, White Shower/Shower, Pipe Mount



**Model 00113001**  
AWARENESS 100™ Sign  
Yellow, Black Shower/Eyewash, Pipe Mount

**Model 00113007**  
AWARENESS 100™ Sign  
Green, White Shower/Eyewash, Pipe Mount

**Model 00113004**  
AWARENESS 100™ Sign  
Orange, Black Shower/Eyewash, Pipe Mount



**Model 00113017**  
AWARENESS 100™ Sign  
Green, White Eyewash/Eyewash, Wall Mount

**Model 00113011**  
AWARENESS 100™ Sign  
Yellow, Black Eyewash/Eyewash, Wall Mount

**Model 00113014**  
AWARENESS 100™ Sign  
Orange, Black Eyewash/Eyewash, Wall Mount

# Accessories and Parts

## AWARENESS® & AWARENESS 360™ Signage

### AWARENESS® 360™

High visibility graphics on chemical resistant ABS plastic shell.

#### MOUNTING

Mounts directly onto shower piping above shower hood.

#### DIMENSIONS

- 16½" x 6" / 41.1 cm x 15.2 cm

#### SHIP WEIGHT

5 lb / 2.27 kg

### AWARENESS® SIGNS

High visibility graphics on chemical resistant ABS plastic shell.

#### MOUNTING CHOICES

Includes tie wraps & trim strip for shower piping stanchion mount.

- For top/bottom entry showers.
- For midpoint entry showers.
- On walls above fountains or below shower.

#### LANGUAGE CHOICES

- English
- French
- Spanish
- Others upon request

#### DIMENSIONS

- 9¼" x 8" x 40" / 23.5 cm x 20.3 cm x 101.6 cm

#### SHIP WEIGHT

5 lb / 2.27 kg



### Model 35001810

AWARENESS 360° Sign Green, White Shower/Eyewash graphics

### Model 01112911

AWARENESS® Sign  
Yellow, Shower/Eyewash,  
Black Letters, Top/Bottom

### Model 01112953

AWARENESS® Sign Green,  
Shower/Eyewash, White  
Letters, Top/Bottom

### Model 01112951

AWARENESS® Sign  
Orange, Shower/Eyewash,  
Black Letters, Top/Bottom



*Note: Sign with Shower/Shower graphic is also available*

### Model 01112942

AWARENESS® Sign  
Orange, Eyewash/  
Eyewash, Black Letters,  
Wall Mount

### Model 01112912

AWARENESS® Sign  
Yellow, Eyewash/Eyewash,  
Black Letters, Wall Mount

### Model 01112946

AWARENESS® Sign Green,  
Eyewash/Eyewash, White  
Letters, Wall Mount



## Emergency Signs

White placard sign with green letters and graphics.

Suitable for wall mounting or pipe mounting (hardware not included.)

### DIMENSIONS

- 7" x 11" & 8" x 18" / 17.8 cm x 27.9 cm & 20.3 cm x 45.7 cm

**Model 01112892**  
Emergency Shower/  
Eyewash Sign, 7" x 11" /  
17.8 cm x 27.9 cm

**Model 01112847**  
Emergency Shower/  
Eyewash Sign, 8" x 18" /  
20.3 cm x 45.7 cm



**Model 01112893**  
Emergency Eyewash Sign,  
7" x 11" / 17.8 cm x 27.9 cm

**Model 01112848**  
Emergency Eyewash Sign,  
8" x 18" / 20.3 cm x 45.7 cm



**Model 01112891**  
Emergency Shower Sign, 7"  
x 11" / 17.8 cm x 27.9 cm

**Model 01112846**  
Emergency Shower Sign, 8"  
x 18" / 20.3 cm x 45.7 cm

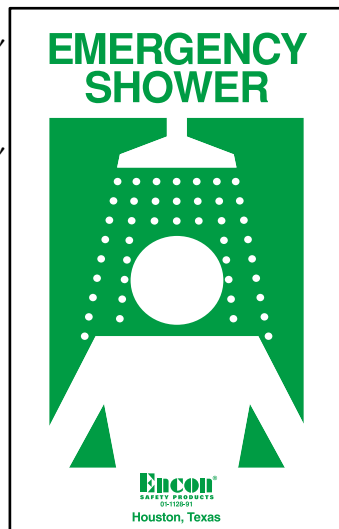

**Model 01112900**  
Drench Hose Station, 7" x  
11" / 17.8 cm x 27.9 cm



# Accessories and Parts

## Shower Accessories & Test Units

### MODESTY CURTAIN ASSEMBLY

Provides immediate privacy; easily mounts to most floor mounted shower stations.  
Includes ABS plastic blocks, SS rod & support bracket with SS U-bolts to hold assembly in place. Large hooks included.

- 70" x 145" / 177.8 cm x 368.3 cm high visibility yellow
- Water-resistant PVC nylon-coated heavy duty material with weighted bottom
- Clean Room Option — for electronic clean room; highly fluid repellent; 70" x 145" / 177.8 cm x 368.3 cm

SHIP WEIGHT  
15 lb / 6.80 kg

### SHOWER SHELTER

3-sided wind break structure

- SS clamp & hardware,
- Galvanized steel pipe supports & flanges
- Fiberglass panels and molded roof
- 111" x 45" x 51" / 281.9 cm x 114.3 cm x 129.5 cm

SHIP WEIGHT  
345 lb / 156.49 kg

### SHOWER TEST UNIT

Light weight, durable and portable PVC-coated nylon test chute for volume flow testing of shower.  
Large opening with drawstring secures around shower head & hemmed bottom to neatly direct water into bucket

### MOBILITY CHOICES

- Cart — High visibility yellow with 10" / 25.4 cm semi-pneumatic back wheels and 6" / 15.2 cm locking front casters
- Dolly — A wheel castered square dolly; twist on/off receptacle

SHIP WEIGHT  
81 lb / 36.74 kg

### Model 01052149

Modesty Curtain Assembly  
(shower not included)



### Model 01052187

Modesty Curtain Replacement Kit



### Model 01080024

Shower Shelter  
(shower not included)



### Model STU1

Shower testing mobile cart with receptacle and chute  
(shower not included)



## Shower Accessories & Test Units

### TREADLE KIT ASSEMBLY

ABS foot treadle with chain usable for indoor applications

SHIP WEIGHT

1 lb / 0.45 kg

### RETROFIT DRENCH HOSE KITS

- ½" / 1.3 cm Tee connection with squeeze valve and lock open handle
- ½" / 1.3 cm Tee connection with push plate and stay-open chrome plated ball valve
- 6' / 1.8 m Neoprene® rubber hose, yellow ABS head with float off cover, support bracket

SHIP WEIGHT

1 lb / 0.45 kg

### DRAIN PAN

- 36" x 36" / 91.4 cm x 91.4 cm high visibility yellow gel coating, 6" / 15.2 cm depth fiberglass shower catch basin
- Attaches to 1" / 2.5 cm structural open grates in multi-level process areas
- PVC slip joint 2" / 5.1 cm inside, 3" / 7.6 cm outside
- SS nuts, bolts & washer; galvanized steel clips

SHIP WEIGHT

50 lb / 22.67 kg



### Model 01052232

Drain pan assembly,  
36" x 36" / 91.4 cm x 91.4 cm



### Model 01052382

Treadle Kit



### Model 01090098

6' / 1.8 m Drench hose with ABS Head & Self-Close Locking BCP Valve, ½" / 1.3 cm Tee Connection



### Model 01090017

6' / 1.8 m Drench hose with ABS Head,  
Push Plate CP Valve

# Accessories and Parts

## Assemblies - Heads & Nozzels



**Model 01052123**  
Eyewash Assembly, ABS Heads & Wye w/Flip Lids, 1/2" / 1.3 cm Inlet, 3.2 gpm / 12.1 lpm  
**Model 01052185**  
Eyewash Assembly, ABS Heads & Wye w/Flip Lids, 3/8" / 1 cm Inlet, 3.2 gpm / 12.1 lpm

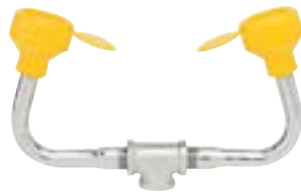

**Model 01052132**  
Eyewash Assembly, Acetal Heads w/Hinged Covers, BCP Wye, 1/2" / 1.3 cm Inlet, 2.4 gpm / 9.1 lpm  
**Model 01052129**  
Eyewash Assembly, Acetal Heads w/Hinged Covers, BCP Wye, 3/8" / 1 cm Inlet, 2.4 gpm / 9.1 lpm



**Model 01052208**  
Eyewash Assembly, Low Profile, Acetal Heads w/Hinged Covers, BCP Wye, 3/8" / 1 cm Inlet, 2.4 gpm / 9.1 lpm



**Model 01052263**  
Eyewash Assembly, SS Heads & Wye, w/Hinged Covers, 1/2" / 1.3 cm Inlet, 2.5 gpm / 9.5 lpm



**Model 01052045**  
Eyewash Head, Plastic 1/4" / 0.6 cm NPT 1.2 gpm / 4.5 lpm Regulated w/Hinge Cap  
**Model 01052037**  
Eyewash Head, Plastic 1/4" / 0.6 cm NPT 1.4 gpm / 5.3 lpm Regulated w/Hinge Cap



**Model 01052122**  
Facewash Assembly, ABS Heads & Wye w/Covers, SS Bead Chain, 1/2" / 1.3 cm Inlet, 8 gpm / 30.3 lpm  
**Model 01052189**  
Facewash Assembly, ABS Heads & Wye w/Covers, SS Bead Chain, 3/8" / 1 cm Inlet, 8 gpm / 30.3 lpm



**Model 01052133**  
Facewash Assembly, ABS Heads & BCP Wye w/Covers, SS Bead Chain, 1/2" / 1.3 cm Inlet, 8 gpm / 30.3 lpm  
**Model 01052130**  
Facewash Assembly, ABS Heads & BCP Wye w/Covers, SS Bead Chain, 3/8" / 1 cm Inlet, 8 gpm / 30.3 lpm



**Model 01052040**  
Facewash Head only, 1/4" / 0.6 cm NPT  
**Model 01052041**  
Drench Hose Head only, 3/8" / 1 cm NPT



**Model 01054005**  
Shower Head Assembly, Yellow ABS, integral 20 gpm / 75.7 lpm regulator, 1" / 2.5 cm connection



**Model 01054003**  
Shower Head Assembly, Yellow ABS, integral 30 gpm / 113.6 lpm regulator, 1" / 2.5 cm connection



**Model 01055005**  
Shower Head Assembly, SS, integral 30 gpm / 75.7 lpm regulator, 1" / 2.5 cm connection

**Model 01055007**  
Shower Head Assembly, SS, integral 20 gpm / 113.6 lpm regulator, 1" / 2.5 cm connection



**Model 01120002**  
ABS Bowl Cover Kit for Encon Eyewash Yello-Bowl®

## Bowls & Covers

# Accessories and Parts

## Bowls & Covers



**Model 01120001**  
ABS Bowl Cover Kit for Encon Facewash Yello-Bowl®



**Model 01110462**  
Encon Yello-Bowl®, ABS



**Model 01110096**  
Bowl, Stainless Steel



**Model 01052020**  
Facewash Cover with 10" / 25.4 cm SS Bead Chain

## Self-Contained



**Model 01052113**  
Eyewash Cover with 8" / 20.3 cm SS Bead Chain



**Model 01110764**  
Hydrosep® water additive - 4pk



**Model 01110802**  
Hydrosep® QT water additive - 12/case



**Model 01110803**  
Hydrosep® GL water additive - Four, 1-gallon jugs per case



**Model 01110738**  
Gravity Fed Eyewash "J Hook" mounting bracket



**Model 01110741**  
Mounting bracket for Helios®



**Model 00015003**  
Gravity Fed Eyewash Receptacle, 28 gal / 106 L, grey plastic



**Model 01110700**  
Transport Cart & Receptacle - For Gravity Fed and Aqurion® only  
**Model 01110302**  
Transport Cart only - For Gravity Fed and Aqurion® only



**Model 00014314**  
Air Gauge for Pressurized Portable



**Model 00014337**  
Hose, 1/4" x 8' / 0.6 cm x 243.8 cm Red recoil



**Model 01052124**  
Nozzel assembly, for 00011406 portable drenching hose, 0.4 gpm / 1.5 lpm



**Model 01052131**  
Eyewash head cover, with 8" / 20.3 cm SS bead chain, for 01052111A

# Accessories and Parts



**Model 01105001**  
Relief valve retrofit kit for self-contained portable, 115 psi



**Model 00011077**  
Relief valve only, 115 psi



**Model 01105005**  
Drench Hose Assembly



**Model 01052111**  
Eyewash Assembly with ABS Heads, Wye & Covers, SS bead chain, 1/2" / 1.3 cm Inlet, 0.4 gpm / 1.5 lpm, for self contained portable

## Activation Kits & Valves



**Model 01052103**  
Ball Valve Kit for Shower, 1 1/4" / 3.2 cm BCP, with Nut



**Model 01052120**  
Ball Valve Kit, 1" / 2.5 cm for Emergency Showers



**Model 01052018**  
Push Plate, SS with Decal



**Model 01052101**  
Ball Valve Kit for Eyewash, 1/2" / 1.3 cm BCP, with Nut, Push Plate

**Model 01052104**  
Ball Valve Kit, Shower, 1 1/4" / 3.2 cm SS with Nut

**Model 01052197**  
Ball Valve Kit, 1" / 2.5 cm horizontal, SS with actuator arm



**Model 01052114**  
Ball Valve Kit for Eyewash, 1/2" / 1.3 cm Self-drain, with Push Plate



**Model 01052001**  
Pull Rod, SS with Graphic & Pin Fastener, 29" / 73.7 cm



**Model 01052065**  
Ball Valve Kit, 1 1/4" / 3.2 cm BCP, with 29" / 73.7 cm SS Pull Rod Actuator



**Model 01110142**  
Extension Stem 2 1/4" / 5.7 cm for 1/2" / 1.3 cm Ball Valve Freeze Protection



**Model 01110147**  
Extension Stem for 1 1/4" / 3.2 cm or 1 1/2" / 3.8 cm Ball Valve Freeze Protection

**Model 01052086**  
Ball Valve Kit, 1" / 2.5 cm BCP, with 29" / 73.7 cm SS Pull Rod Actuator

# Accessories and Parts

## Protection Valves & Fittings



**Model 00011082**  
Freeze Protection Valve, 1/2" / 1.3 cm opens at 35°F / 2°C



**Model 03900006**  
Freeze Protection Valve Assembly, for exterior drain at 35°F / 2°C



**Model 00011081**  
Scald Protection Valve 1/2" / 1.3 cm opens at 95°F / 35°C



**Model 03900003**  
Scald Protection Valve Assembly, for exterior drain at 95°F / 35°C

## Alarms



**Model 01052098**  
Strainer Tee Assembly, BCP, 1/2" / 1.3 cm, 16 Mesh



**Model 00013460**  
Clear Light Globe



**Model 00013582**  
Blue Light Globe



**Model 00013571**  
Green Light Globe



**Model 00014606**  
Red Light Globe



**Model 00014685**  
Flow Switch Assembly, 2 gpm / 7.6 lpm, 1" / 2.5 cm



**Model 00014683**  
Flow Switch Bonnet, 2 gpm / 7.6 lpm



**Model 00013319M**  
MAP® Switch & Magnet

## Curtains & Testing Accessories



**Model 01110447**  
Hook for Modesty Curtain, Zinc Plated



**Model 01110593**  
Hook for Mod Curtain, Stainless Steel



**Model 01112894**  
Shower eyewash inspection tag, yellow

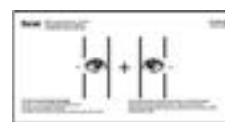

**Model 01110469**  
Eye/Facewash Test Gauge to ANSI Z358.1



**Model 02570001**  
Shower Tester Chute

## Representative Performance Data & Limited Warranty Statement

*Encon utilizes self-adjusting flow regulators to deliver a constant, even flow under varying hydraulic conditions. ANSI Standard Z358.1 requires a minimum dynamic (flowing) pressure of 30 psi. It is important to include dynamic pressure drops through the potable water system when calculating system hydraulic requirements. Dynamic pressure above 80 psi to shower and eyefacewash equipment is not recommended.*

	Dynamic Pressure	GPM / LPM Output
Eyewash Dual-stream Heads	30	3.2 / 12.1
	40	3.4 / 12.9
	50	3.5 / 13.2
	60	3.6 / 13.6
	70	3.7 / 14
Eye/Facewash Dual-stream Heads	30	7.0 / 26.5
	40	7.5 / 28.4
	50	8.0 / 30.3
	60	8.5 / 32.2
	70	9.0 / 34.1
Regulated Showers on Combination Units with 20 gpm / 75.7 lpm shower & 8 gpm / 30.3 lpm FW	40	28 / 106
	30	38 / 143.8
	40	23.5 / 89
	30	33.5 / 126.8
Hand-held Drench Hose with squeeze valve, black-braided hose (Nylon recoil hose requires minimum 45 psi)	30	3.6 / 13.6
	40	4.5 / 17
	50	4.8 / 18.2
	60	4.9 / 18.5
	70	5.0 / 18.9
Hand-held Drench Hose with stay-open valve, black-braided hose (Nylon recoil hose requires minimum 45 psi)	30	5.3 / 20.1
	40	6.0 / 22.7
	50	6.9 / 26.1
	60	7.5 / 28.4
	70	7.8 / 29.5

*WITH RESPECT TO EMERGENCY SHOWERS (THE "EQUIPMENT") ENCON SAFETY PRODUCTS HEREBY DISCLAIMS ALL WARRANTIES, EXPRESSED OR IMPLIED, INCLUDING THE IMPLIED WARRANTY OF MERCHANTABILITY AND FITNESS FOR A PARTICULAR PURPOSE, EXCEPT AS HEREAFTER PROVIDED.*

*ENCON warrants the Equipment to be free of defects in material and workmanship if properly installed, cared for, and operated under normal conditions, with competent supervision, and in accordance with ENCON installation, operating, and maintenance instructions. With respect to the Equipment, ENCON's only obligation under this warranty is to repair or replace such components of the Equipment:*

*As prove defective and ENCON is so advised within one year after shipment, and shall appear to ENCON's satisfaction to have been defective in material or workmanship. However, in no event shall ENCON be liable under this Warranty unless ENCON is provided an opportunity to inspect such material or workmanship and, at its option, allowed to repair or replace such material or workmanship.*

*No warranty is given in connection with any portion of the Equipment, which is altered or rebuilt without ENCON's express written consent.*

*ENCON shall not be liable for loss, damage, or expense, arising directly, or indirectly, as a consequence of use of the Equipment with other products, or from any other cause, other than ENCON's obligation to repair or replace defective components of the Equipment as expressly provided in this warranty statement.*

*THE CUSTOMER'S PURCHASE AND ACCEPTANCE OF THE EQUIPMENT SHALL BE DEEMED TO BE ITS AGREEMENT TO BE BOUND BY THE TERMS AND PROVISIONS OF THIS WARRANTY.*

*Under no circumstances will ENCON ever be liable for indirect or consequential loss or damage arising out of the ownership or use of the Equipment.*

*The terms of this warranty shall apply to any replacement parts installed on, or furnished in connection with, the Equipment.*

*The equipment was designed using information and specifications supplied by the customer and sized and fitted, using common piping elements, accordingly. ENCON is not liable for the correctness of any design, materials or construction criteria furnished or specified in the equipment performance specification documents.*

# Numerical Parts Index

<u>Part No.</u>	<u>Page No.</u>	<u>Part No.</u>	<u>Page No.</u>	<u>Part No.</u>	<u>Page No.</u>	<u>Part No.</u>	<u>Page No.</u>
00011077	52	01050207	5	01052086	52	01110700	51
00011081	53	01050209	6	01052098	53	01110738	51
00011082	53	01050209P20	6	01052101	52	01110741	51
00013319M	53	01050210	13	01052103	52	01110764	21
00013460	53	01050216	5	01052104	52	01110764	51
00013571	53	01050217	5	01052111	52	01110786S	25
00013582	53	01050217P20	5	01052113	51	01110793S	25
00014314	51	01050217P20PBC	6	01052114	52	01110802	51
00014337	51	01050217PBC	6	01052120	52	01110803	51
00014606	53	01050219	10	01052122	50	01112846	47
00014683	53	01050219P20	10	01052123	50	01112847	47
00014685	53	01050221	9	01052124	51	01112848	47
00015003	51	01050221P20	9	01052129	50	01112891	47
00015006	22	01050223	10	01052130	50	01112892	47
00113000	45	01050223P20	10	01052131	51	01112893	47
00113001	45	01050224	9	01052132	50	01112894	53
00113003	45	01050224P20	9	01052133	50	01112900	47
00113004	45	01050228	13	01052149	48	01112911	46
00113006	45	01050230	7	01052155	43	01112912	46
00113007	45	01050230P20	7	01052185	50	01112942	46
00113011	45	01050230P20PBC	8	01052187	48	01112946	46
00113014	45	01050230PBC	8	01052189	50	01112951	46
00113017	45	01050232	10	01052197	52	01112953	46
01030101	30	01050232P20	10	01052208	50	01114021	30
01030103	30	01050234	7	01052232	49	01120001	51
01030104	17	01050234P20	7	01052263	50	01120002	50
01030106	18	01050234P20PBC	8	01052382	49	02000200	44
01030301	29	01050234P20SBC	8	01052501	14	02000300	44
01030302	31	01050234PBC	8	01052502	14	02100000	44
01030310	32	01050234SBC	8	01052522	14	02111000	43
01030316PBC	32	01050236	11	01052524	14	02200000	44
01030401	27	01050236P20	11	01053001	14	02211300	44
01030403	27	01050236P20SBC	11	01053001P20	14	02311000 240	44
01030416	27	01050236SBC	11	01054003	50	02570001	53
01035401	29	01050251	5	01054005	50	03900003	53
01035402	31	01050260	5	01055005	50	03900006	53
01035410	32	01050264	11	01055007	50	35001810	46
01035415PBC	32	01050264S20	11	01060007	12	AQ100	20
01035501	27	01050266P20PBC	7	01060009	12	AQ100H130	20
01035503	27	01050266PBC	7	0106009P20	12	AQ100S	20
01035511	27	01050276	13	01060021	12	AQ110	20
01035601	30	01050277	13	01060022	12	AQ111	20
01035603	30	01050281	7	01080024	48	AQ120	20
01035604	17	01050281P20	7	01090017	49	FRSSC-G	17
01035606	18	01050288	6	01090098	49	FRSSC-GP20	17
01038301	29	01050288P20	6	01101001	25	HE100	21
01038801	29	01050290	6	01103001	25	HF100	21
01040103	30	01050290P20	6	01103002	23	HS100	21
01040135	30	01050293	8	01103004	23	STF30WB120G	42
01045001	28	01050293P20	8	01103006	23	STF30WP120C	42
01045001PBC	28	01050294	18	01103008	23	STF60WB120G	42
01045001SBC	28	01050294P20	18	01104002	23	STU1	48
01045002	31	01050314	16	01104050	22	TF34B2300001	34
01045002SBC	31	01050314P20	16	01104050C	22	TF35B5376300	34
01045005	29	01050317	16	01104050S	22	TF36B2000302	34
01045006	32	01050317P20	16	01104055	22	TP21323230	36
01045008	32	01050362	16	01104070	22		
01045010	28	01050362P20	16	01105001	52		
01045501	28	01050376	13	01105005	52		
01045501PBC	28	01050381	13	01106001	24		
01045501SBC	28	01050470	11	01106002	24		
01045502	31	01050470S20	11	01106004	24		
01045505	29	01050471S20SBC	9	01110096	51		
01045506	32	01050471SBC	9	01110142	52		
01045502SBC	31	01052001	52	01110147	52		
01045510	28	01052018	52	01110302	21		
01045514	32	01052020	51	01110302	51		
01045601	30	01052037	50	01110447	53		
01050201	17	01052040	50	01110462	51		
01050201P20	17	01052041	50	01110469	53		
01050205	9	01052045	50	01110593	53		
01050205P20	9	01052065	52				

SAFETY

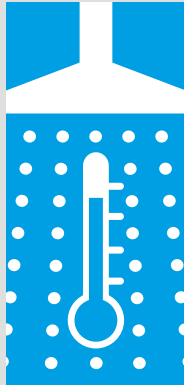

PROTECTION



EXCELLENCE

SOLUTIONS

LEADERS



**Encon**<sup>®</sup>  
SAFETY PRODUCTS

6825 West Sam Houston Pkwy. North, Houston, TX 77041  
Toll Free: 1(800) AT ENCON 1(800) 283-6266  
Fax: (713) 466-1703  
customerservice@enconsafety.com  
www.enconsafety.com  
ESEWFULL-08-25-2017

WALL  
CASES



SELF-CONTAINED



PARTS



ENGINEERED



QUALITY

